

Product Information

Materials Testing Machines AllroundLine Z005 to Z100

CTA: 42569 42597



AllroundLine Z010 TN with optional base



AllroundLine Z100 TEW with optional support legs

Applications

The load frames of the AllroundLine table-top testing machines are used for almost all tests where low to medium specimen elongation occurs. One, or optionally two test areas are available. For applications outside of ambient temperature, the table-top testing machines can also be equipped with a temperature chamber.

The table-top testing machines Z005 to Z150 are designed for quasi-static tests in tensile and compression directions, with continuous, static, pulsating or cyclic load. The drive is electromechanical.

Advantages and features



Integrated safety in accordance with the EC Machinery Directive

Maximum level of safety for user and testing system is guaranteed. All EC Machinery Directive safety requirements are guaranteed. Compliance is documented with an EC Declaration of Conformity. State-of-the-art safety technology and proven industrial components that comply with the highest level of safety and industrial standards (IEC 60947) are used.



Powerful AC Drive Technology

The powerful and maintenance-free AC drive allows you to perform tests anytime at full test load and speed. Furthermore, reverse speeds far above the possible nominal speed. This is combined with an innovative motor feedback system, allowing excellent constant speed characteristics to be achieved even at extremely low speeds.

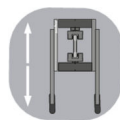

High operating comfort

- Ergonomic operation is the key feature of the new AllroundLine machine.
- The machine is adjustable for optimum individualized ergonomic configuration; modular design allows adaptation as needed and when required.
- Adjustable upright profiles combined with low base-height enable flexible variation of the working area. This also allows wheelchair-friendly operation.

Product Information

Materials Testing Machines AllroundLine Z005 to Z100

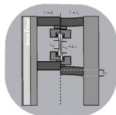

High stiffness and precise crosshead guidance

The stiff load-frame profile, generous connecting surfaces and ruggedly dimensioned components ensure high machine stiffness. The inclination angle of the crosshead under load is reduced, enabling very precise alignment and application of force to the specimen. This is advantageous for flexure tests, compression tests, precision tests on components etc.

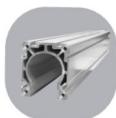

Modern load-frame design

AllroundLine is equipped with a patented, flexurally stiff hollow profile with guide-cylinder. Long guides with generous surface areas ensure high-precision crosshead guidance. This combination minimizes undesired mechanical influences on the specimen. T-slots incorporated into the profile provide flexible mounting options.

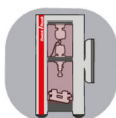

Two test areas

With the second test area, different tests can be performed on one materials testing machine without having to change tools. This guarantees reproducible test results, and the need for a second testing machine is eliminated. In addition, both test environments can be operated with one load cell, saving in acquisition and calibration costs.

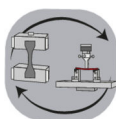

Mechanical Modularity

Mechanical modularity enables the testing system to be expanded by the wide range of ZwickRoell test fixtures and specimen grips or with customized devices. This is where the highly adaptable, play-free plug and T-slot system comes into its own, backed by a wide variety of crosshead mount options. Specimen grips and test tools can be changed whenever required, enabling a wide range of tests to be performed with the same testing machine and allowing rapid, highly flexible adaptation to the current testing situation.



Ready for the Next Generation

Modular design means that the testing system can be re-equipped or upgraded whenever required. Moreover, testControl II machine electronics are compatible with future-generation ZwickRoell software. Even after a product has been discontinued, spare parts continue to be available for a minimum of 10 years.

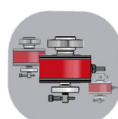

Exclusively at ZwickRoell: Xforce Load Cells

Patented Xforce load cells are developed and manufactured by ZwickRoell, and offer outstanding accuracy and high resistance to parasitic influences. Parasitic influences such as temperature and transverse forces have significantly less impact on test results than other comparable sensors. Xforce load cells are also very robust and more resistant to factors such as transverse forces during compression and flexure tests.



Safety for the entire testing system

The highest level of safety is achieved with the two-channel safety circuit. It includes the crosshead limit switch, the drive-Off switch, motor break function and the operation mode switch. Relevant accessories are also integrated into the safety circuit. The CE-compliant safety device with electrical interlocking and mechanical guard locking prevents interference with the machine during the test.



ZwickRoell Engineering – Made in Germany

The development and manufacture of materials testing machines, including all mechanical, electronic and software components, together with our comprehensive range of accessories, takes place at ZwickRoell's production facility in Germany, enabling us to create a product that is perfectly harmonized. Each materials testing machine is made of the highest quality standard enabling ZwickRoell to offer the best possible support.

Product Information

Materials Testing Machines AllroundLine Z005 to Z100

Overview of the key advantages of testControl II machine electronics



Innovative testControl II machine electronics

All ZwickRoell materials testing machines are equipped with the powerful testControl II measurement and control electronics, offering the ideal basis for precise, reproducible test results.

The electronics are mounted vertically on the side of the load frame. This position protects the electronics from penetration of liquids and conductive particles.

The high-quality surfaces protect testControl II from external influences. In addition, the components used are highly durable.



testControl II machine electronics and testXpert III testing software—a powerful combination

testXpert III testing software and testControl II machine electronics are perfectly matched, ensuring safe and efficient operation of the testing system. testXpert III provides the optimal solution for any testing requirement.

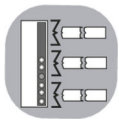

Flexibility Through Modularity

testControl II offers six flexible time-synchronized slots. These make it possible to use multiple sensors at the same time, and can be monitored and protected irrespective of use.

- For example, an extensometer and a transverse strain extensometer can be used in addition to the load cell.
- If the testing system is equipped with several load cells or additional sensors, these can all remain plugged in. All plugged-in sensors are automatically protected against overloads.

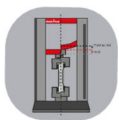

Machine compliance correction

Due to the high-quality drive technology and real-time correction of the machine compliance during the test, target positions are approached with accuracy and travel is precisely determined with the crosshead travel monitor. The testXpert III testing software automatically sets the optimal correction curve, guaranteeing the highest possible level of precision.

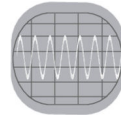

High data transmission rate

Each travel and force peak is acquired with high resolution and recorded synchronously at 500 Hz on all measuring channels. Optionally, the measured value acquisition rate can be expanded to 2,000 Hz. The high data transmission rate enables fast measurement with the highest degree of reproducibility. This is highly advantageous for quick tests, short, brittle fracture events and in tear-growth, adhesion and peel tests.



System monitoring

testControl II system monitoring provides the user/laboratory manager with detailed information on the current status and level of utilization of the testing equipment. This enables further increases in testing equipment availability and greatly simplifies maintenance planning and spares/replacement procurement.



Fast, adaptive drive controller

The high drive control frequency of 1,000 Hz delivers fast, precise force and strain control. Benefits include enabling components to be loaded very quickly and accurately with a predetermined force.



Maximum accuracy

The smallest force changes on the specimen are quickly and accurately recorded and displayed. The A/D converter guarantees high measured-value accuracy over a wide measurement range with sampling rates of 400 kHz and 24 bit resolution.



Innovative Interfaces

The innovative EtherCat® interface is incorporated as standard. The time-synchronized real-time Ethernet field bus system ensures future-proof integration of sensors and power units.



Eco mode

The testControl II machine electronics automatically switch to eco mode when not in use, saving energy.

Product Information

Materials Testing Machines AllroundLine Z005 to Z100



Ergonomic remote control with color display

Tests can be performed entirely via the display-equipped remote control, independent of the PC. All important information is shown on the color display. Machine operation is therefore more ergonomic and effective. Maximum operator safety is guaranteed with the integrated Emergency stop. The rocker-switch with integrated dial makes positioning fast yet highly accurate.

Scale diagrams

CTA: 52321 52322

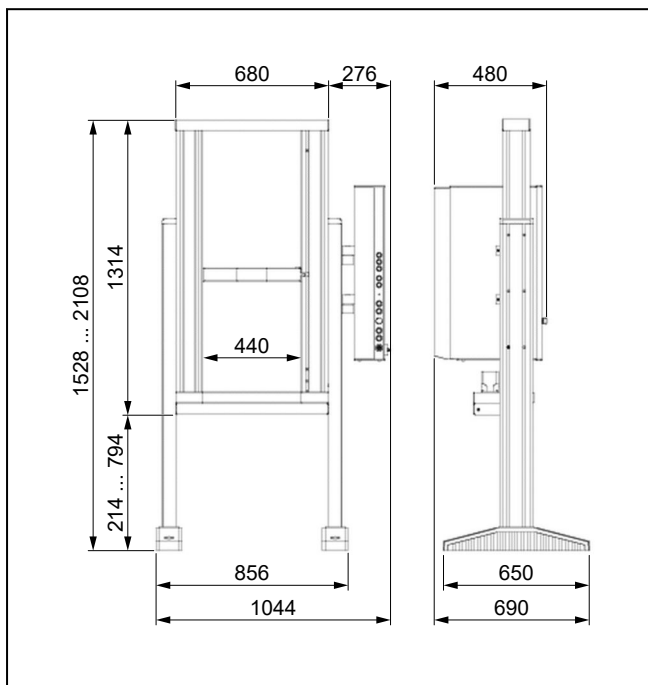

Z005 TN, Z010 TN, Z020 TN

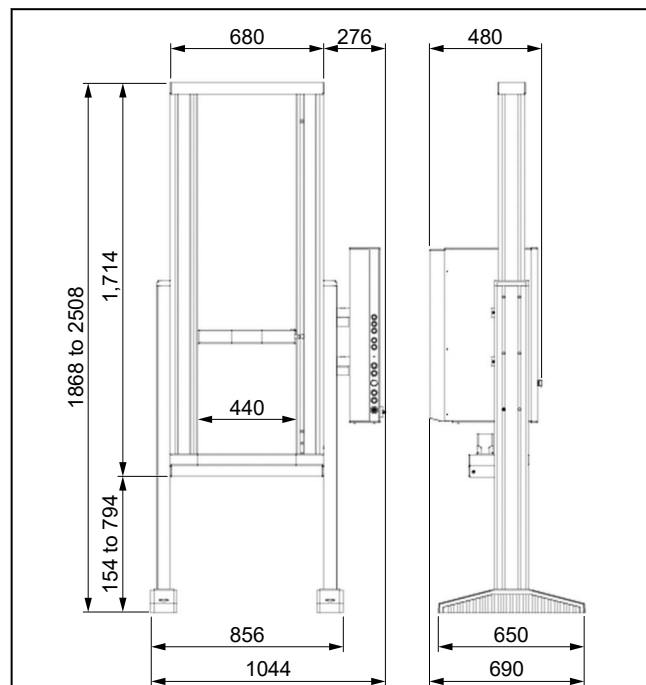

Z005 TH, Z010 TH, Z020 TH

Product Information

Materials Testing Machines AllroundLine Z005 to Z100

CTA: 52328 52325

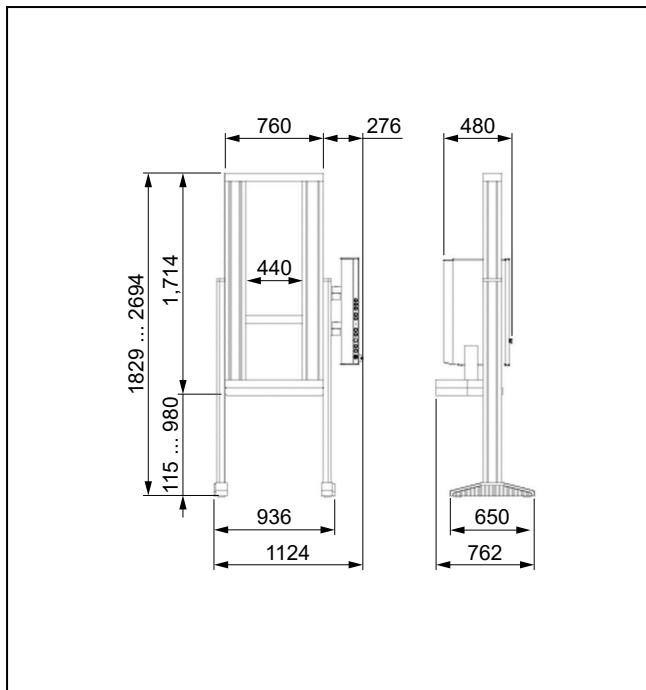

Z030 TH, Z050 TH

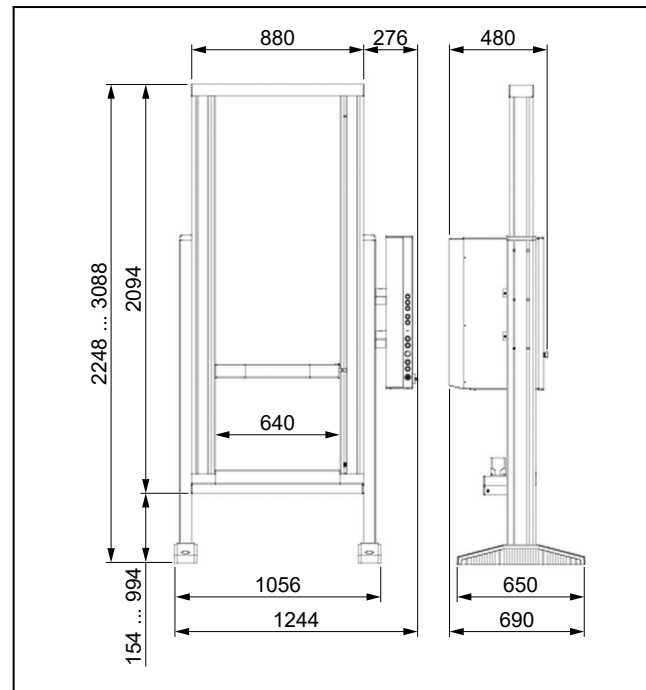

Z010 TEW, Z020 TEW

CTA: 52331 52329

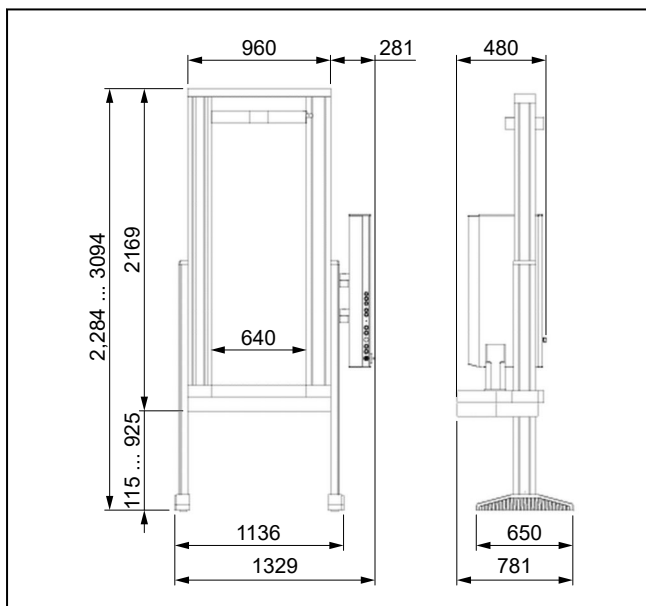

Z100 TEW

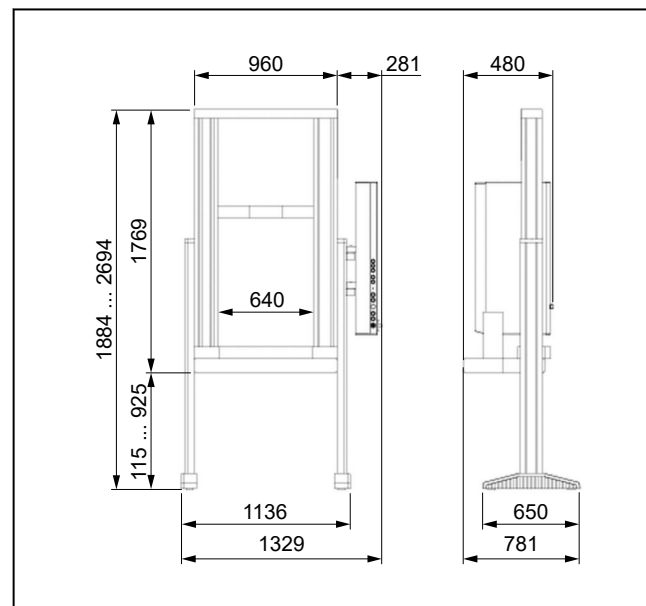

Z100 THW

Product Information

Materials Testing Machines AllroundLine Z005 to Z100

Technical data

General technical data for AllroundLine table-top testing machines

Load frame		
Paint finish	RAL 7021 and RAL 7038	
Ambient temperature	+10 ... +35	°C
Relative humidity (non-condensing)	20 ... 90	%
Drive system		
Motor	AC servo motor with concentrated windings, Hiperface® motor feedback system	
Control, set value preselection	Digital (real-time Ethernet, EtherCAT®)	
Controller	Adaptive	
Cycle time	1000	Hz
Positioning repeatability (without reversal of direction)	±2.0	µm
Power input specifications		
Permissible voltage fluctuation	± 10	%
Power frequency	50/60	Hz

Description	Value	
Machine electronics		
Number of available slots for measurement and control modules:		
Synchronized module bus slots	2 (expandable to 5) ¹⁾	
Synchronized PCIe slots	1	
Force measurement	Class 0.5/1, depending on load cell, compliant to DIN EN ISO 7500-1, ASTM E4	
Measurement range	Up to 165% of Fmax	
Calculated resolution (e.g., load cell in tensile/compression direction)	24	bit
Effective resolution in tensile/compression direction:		
DCSC module	19 bits (corresponds to ±524,000 points)	
USC module	20 bits (corresponds to ±1,000,000 points)	
Measured value acquisition rate	400	kHz
Measurement value transmission rate to PC	500 (optional 2000)	Hz
Zero-point correction	Automatic, at start of measurement	
Measurement signal runtime correction	Yes	
Interface to PC	Ethernet	
Eco mode	Yes, automatic switch off of power section (time can be set)	
CE conformity	Yes, according to Machinery Directive 2006/42/EC	

¹⁾ A DCSC module is included in the scope of delivery (occupies one module slot).

Product Information

Materials Testing Machines AllroundLine Z005 to Z100

Z005 TN, TH, TE

Type	Z005 TN	Z005 TH	Z005 TE	
Item No.	1004473	1004476	1004478 ¹⁾	
Test load F_{max}	5	5	5	kN
Test area				
Height				
Lower test area	1030	1430	1785	mm
Upper test area (additional crosshead required)	1015	1415	1785	mm
Width	440	440	440	mm
Load frame				
Dimensions				
Height	1314	1,714	2084	mm
Height with support legs	1528 ... 2108	1868 ... 2508	2238 ... 3078	mm
Width	680	680	680	mm
Width with support legs	856	856	856	mm
Width with support legs and machine electronics	1044	1044	1044	mm
Depth with machine electronics	573 ²⁾	573 ²⁾	573 ²⁾	mm
Depth with support legs and machine electronics	690	690	690	mm
Weight				
With machine electronics, approx.	161	183	205	kg
With machine electronics and support legs, approx.	192	217	239	kg
Average noise level at v_{max} measured in 1 m distance to the front side of machine	67	67	67	dB(A)
Drive system				
Crosshead speed $v_{min} \dots v_{max}$	0.0005 ... 3000 ³⁾	0.0005 ... 3000 ³⁾	0.0005 ... 3000 ³⁾	mm/min
Crosshead return speed, max.	3000 ³⁾	3000 ³⁾	3000 ³⁾	mm/min
Deviation from the set drive speed, max.	0.05	0.05	0.05	% of v_{actual}
Drive travel resolution	0.959431	0.959431	0.959431	nm
Power input specifications				
Power supply	230	230	230	V, 1Ph/N/PE
Power consumption (full load), approx.	2	2	2	kVA

1) Support legs are included in the delivery of this testing system.

2) Including base (rectangular pipe 60 x 30 mm) with 210 mm overhang at the front

3) Values apply to machines with the safety doors closed in automatic mode and to machines without safety devices. For machines with the safety door open, the speed is reduced to 600 mm/min.

Product Information

Materials Testing Machines AllroundLine Z005 to Z100

Z005 TNW, THW

Type	Z005 TNW	Z005 THW	
Item No.	1004475	1004477	
Test load F_{max}	5	5	kN
Test area			
Height			
Lower test area	1000	1400	mm
Upper test area (additional crosshead required)	1015	1415	mm
Width	640	640	mm
Load frame			
Dimensions			
Height	1324	1724	mm
Height with support legs	1538 ... 2118	1878 ... 2518	mm
Width	880	880	mm
Width with support legs	1056	1056	mm
Width with support legs and machine electronics	1244	1244	mm
Depth with machine electronics	573 ¹⁾	573 ¹⁾	mm
Depth with support legs and machine electronics	690	690	mm
Weight			
With machine electronics, approx.	208	230	kg
With machine electronics and support legs, approx.	242	264	kg
Average noise level at v_{max} measured in 1 m distance to the front side of machine	67	67	dB(A)
Drive system			
Crosshead speed $v_{min} \dots v_{max}$	0.0005 ... 3000 ²⁾	0.0005 ... 3000 ²⁾	mm/min
Crosshead return speed, max.	3000 ²⁾	3000 ²⁾	mm/min
Deviation from the set drive speed, max.	0.05	0.05	% of v_{actual}
Drive travel resolution	0.959431	0.959431	nm
Power input specifications			
Power supply	230	230	V, 1Ph/N/PE
Power consumption (full load), approx.	2	2	kVA

1) Including base (rectangular pipe 60 x 30 mm) with 210 mm overhang at the front

2) Values apply to machines with the safety doors closed in automatic mode and to machines without safety devices. For machines with the safety door open, the speed is reduced to 600 mm/min.

Product Information

Materials Testing Machines AllroundLine Z005 to Z100

Z010 TN, TH, TE

Type	Z010 TN	Z010 TH	Z010 TE	
Item No.	1004479	1004481	1004483 ¹⁾	
Test load F_{max}	10	10	10	kN
Test area				
Height				
Lower test area	1030	1430	1785	mm
Upper test area (additional crosshead required)	1015	1415	1785	mm
Width	440	440	440	mm
Load frame				
Dimensions				
Height	1314	1,714	2084	mm
Height with support legs	1528 ... 2108	1868 ... 2508	2238 ... 3078	mm
Width	680	680	680	mm
Width with support legs	856	856	856	mm
Width with support legs and machine electronics	1044	1044	1044	mm
Depth with machine electronics	573 ²⁾	573 ²⁾	573 ²⁾	mm
Depth with support legs and machine electronics	690	690	690	mm
Weight				
With machine electronics, approx.	163	185	207	kg
With machine electronics and support legs, approx.	197	219	241	kg
Average noise level at v_{max} measured in 1 m distance to the front side of machine	64	64	64	dB(A)
Drive system				
Crosshead speed $v_{min} \dots v_{max}$	0.0005 ... 2000 ³⁾	0.0005 ... 2000 ³⁾	0.0005 ... 2000 ³⁾	mm/min
Crosshead return speed, max.	3000 ³⁾	3000 ³⁾	3000 ³⁾	mm/min
Deviation from the set drive speed, max.	0.05	0.05	0.05	% of v_{actual}
Drive travel resolution	0.636632	0.636632	0.636632	nm
Power input specifications				
Power supply	230	230	230	V, 1Ph/N/PE
Power consumption (full load), approx.	2	2	2	kVA

1) Support legs are included in the delivery of this testing system.

2) Including base (rectangular pipe 60 x 30 mm) with 210 mm overhang at the front

3) Values apply to machines with the safety doors closed in automatic mode and to machines without safety devices. For machines with the safety door open, the speed is reduced to 600 mm/min.

Product Information

Materials Testing Machines AllroundLine Z005 to Z100

Z010 TNW, THW, TEW

Type	Z010 TNW	Z010 THW	Z010 TEW	
Item No.	1004480	1004482	1004484 ¹⁾	
Test load F_{max}	10	10	10	kN
Test area				
Height				
Lower test area	1000	1400	1755	mm
Upper test area (additional crosshead required)	1015	1415	1785	mm
Width	640	640	640	mm
Load frame				
Dimensions				
Height	1324	1724	2094	mm
Height with support legs	1538 ... 2118	1878 ... 2518	2248 ... 3088	mm
Width	880	880	880	mm
Width with support legs	1056	1056	1056	mm
Width with support legs and machine electronics	1244	1244	1244	mm
Depth with machine electronics	573 ²⁾	573 ²⁾	573 ²⁾	mm
Depth with support legs and machine electronics	690	690	690	mm
Weight				
With machine electronics, approx.	210	232	254	kg
With machine electronics and support legs, approx.	244	266	288	kg
Average noise level at v_{max} measured in 1 m distance to the front side of machine	64	64	64	dB(A)
Drive system				
Crosshead speed $v_{min} \dots v_{max}$	0.0005 ... 2000 ³⁾	0.0005 ... 2000 ³⁾	0.0005 ... 2000 ³⁾	mm/min
Crosshead return speed, max.	3000 ³⁾	3000 ³⁾	3000 ³⁾	mm/min
Deviation from the set drive speed, max.	0.05	0.05	0.05	% of v_{actual}
Drive travel resolution	0.636632	0.636632	0.636632	nm
Power input specifications				
Power supply	230	230	230	V, 1Ph/N/PE
Power consumption (full load), approx.	2	2	2	kVA

1) Support legs are included in the delivery of this testing system.

2) Including base (rectangular pipe 60 x 30 mm) with 210 mm overhang at the front

3) Values apply to machines with the safety doors closed in automatic mode and to machines without safety devices. For machines with the safety door open, the speed is reduced to 600 mm/min.

Product Information

Materials Testing Machines AllroundLine Z005 to Z100

Z020 TN, TH, TE

Type	Z020 TN	Z020 TH	Z020 TE	
Item No.	1004485	1004487	1004489 ¹⁾	
Test load F_{max}	20	20	20	kN
Test area				
Height				
Lower test area	1030	1430	1785	mm
Upper test area (additional crosshead required)	1015	1415	1785	mm
Width	440	440	440	mm
Load frame				
Dimensions				
Height	1314	1,714	2084	mm
Height with support legs	1528 ... 2108	1868 ... 2508	2238 ... 3078	mm
Width	680	680	680	mm
Width with support legs	856	856	856	mm
Width with support legs and machine electronics	1044	1044	1044	mm
Depth with machine electronics	573 ²⁾	573 ²⁾	573 ²⁾	mm
Depth with support legs and machine electronics	690	690	690	mm
Weight				
With machine electronics, approx.	165	187	209	kg
With machine electronics and support legs, approx.	199	221	243	kg
Average noise level at v_{max} measured in 1 m distance to the front side of machine	61	61	61	dB(A)
Drive system				
Crosshead speed $v_{min} \dots v_{max}$	0.0005 ... 1000 ³⁾	0.0005 ... 1000 ³⁾	0.0005 ... 1000 ³⁾	mm/min
Crosshead return speed, max.	1500 ³⁾	1500 ³⁾	1500 ³⁾	mm/min
Deviation from the set drive speed, max.	0.05	0.05	0.05	% of v_{actual}
Drive travel resolution	0.324947	0.324947	0.324947	nm
Power input specifications				
Power supply	230	230	230	V, 1Ph/N/PE
Power consumption (full load), approx.	2.3	2.3	2.3	kVA

1) Support legs are included in the delivery of this testing system.

2) Including base (rectangular pipe 60 x 30 mm) with 210 mm overhang at the front

3) Values apply to machines with the safety doors closed in automatic mode and to machines without safety devices. For machines with the safety door open, the speed is reduced to 600 mm/min.

Product Information

Materials Testing Machines AllroundLine Z005 to Z100

Z020 TNW, THW, TEW

Type	Z020 TNW	Z020 THW	Z020 TEW	
Item No.	1004486	1004488	1004490 ¹⁾	
Test load F_{max}	20	20	20	kN
Test area				
Height				
Lower test area	1000	1400	1755	mm
Upper test area (additional crosshead required)	1015	1415	1785	mm
Width	640	640	640	mm
Load frame				
Dimensions				
Height	1324	1724	2094	mm
Height with support legs	1538 ... 2118	1878 ... 2518	2248 ... 3088	mm
Width	880	880	880	mm
Width with support legs	1056	1056	1056	mm
Width with support legs and machine electronics	1244	1244	1244	mm
Depth with machine electronics	573 ²⁾	573 ²⁾	573 ²⁾	mm
Depth with support legs and machine electronics	690	690	690	mm
Weight				
With machine electronics, approx.	212	234	256	kg
With machine electronics and support legs, approx.	246	268	290	kg
Average noise level at v_{max} measured in 1 m distance to the front side of machine	61	61	61	dB(A)
Drive system				
Crosshead speed $v_{min} \dots v_{max}$	0.0005 ... 1000 ³⁾	0.0005 ... 1000 ³⁾	0.0005 ... 1000 ³⁾	mm/min
Crosshead return speed, max.	1500 ³⁾	1500 ³⁾	1500 ³⁾	mm/min
Deviation from the set drive speed, max.	0.05	0.05	0.05	% of v_{actual}
Drive travel resolution	0.324947	0.324947	0.324947	nm
Power input specifications				
Power supply	230	230	230	V, 1Ph/N/PE
Power consumption (full load), approx.	2.3	2.3	2.3	kVA

1) Support legs are included in the delivery of this testing system.

2) Including base (rectangular pipe 60 x 30 mm) with 210 mm overhang at the front

3) Values apply to machines with the safety doors closed in automatic mode and to machines without safety devices. For machines with the safety door open, the speed is reduced to 600 mm/min.

Product Information

Materials Testing Machines AllroundLine Z005 to Z100

Z030

Type	Z030 TH	Z030 TE	Z030 THW	Z030 TEW	
Item No.	1004491	1004493 ¹⁾	1004492	1004494 ¹⁾	
Test load F_{max}	30	30	30	30	kN
Test area					
Height					
Lower test area	1355	1755	1325	1725	mm
Upper test area (additional crosshead required)	1380	1780	1365	1765	mm
Width	440	440	640	640	mm
Load frame					
Dimensions					
Height	1,714	2114	1,714	2114	mm
Height with support legs	1829 ... 2694	2229 ... 3094	1829 ... 2694	2229 ... 3094	mm
Width	760	760	960	960	mm
Width with support legs	936	936	1136	1136	mm
Width with support legs and machine electronics	1124	1124	1324	1324	mm
Depth with machine electronics	618 ²⁾	618 ²⁾	618 ²⁾	618 ²⁾	mm
Depth with support legs and machine electronics	762	762	762	762	mm
Weight					
With machine electronics, approx.	240	260	300	340	kg
With machine electronics and support legs, approx.	274	294	334	374	kg
Average noise level at v_{max} measured in 1 m distance to the front side of machine	64	64	64	64	dB(A)
Drive system					
Crosshead speed $v_{min} \dots v_{max}$	0.0005 ... 1000 ³⁾	0.0005 ... 1000 ³⁾	0.0005 ... 1000 ³⁾	0.0005 ... 1000 ³⁾	mm/min
Crosshead return speed, max.	1500 ³⁾	1500 ³⁾	1500 ³⁾	1500 ³⁾	mm/min
Deviation from the set drive speed, max.	0.05	0.05	0.05	0.05	% of v_{actual}
Drive travel resolution	0.529819	0.529819	0.529819	0.529819	nm
Power input specifications					
Power supply	230	230	230	230	V, 1Ph/N/PE
Power consumption (full load), approx.	2.3	2.3	2.3	2.3	kVA

1) Support legs are included in the delivery of this testing system.

2) Including base (rectangular pipe 60 x 30 mm) with 210 mm overhang at the front

3) Values apply to machines with the safety doors closed in automatic mode and to machines without safety devices. For machines with the safety door open, the speed is reduced to 600 mm/min.

Product Information

Materials Testing Machines AllroundLine Z005 to Z100

Z050

Type	Z050 TH	Z050 TE	Z050 THW	Z050 TEW	
Item No.	1004495	1004498 ¹⁾	1004496	1004499 ¹⁾	
Test load F_{max}	50	50	50	50	kN
Test area					
Height					
Lower test area	1355	1755	1325	1725	mm
Upper test area (additional crosshead required)	1380	1780	1365	1765	mm
Width	440	440	640	640	mm
Load frame					
Dimensions					
Height	1,714	2114	1,714	2114	mm
Height with support legs	1829 ... 2694	2229 ... 3094	1829 ... 2694	2229 ... 3094	mm
Width	760	760	960	960	mm
Width with support legs	936	936	1136	1136	mm
Width with support legs and machine electronics	1124	1124	1324	1324	mm
Depth with machine electronics	618 ²⁾	618 ²⁾	618 ²⁾	618 ²⁾	mm
Depth with support legs and machine electronics	762	762	762	762	mm
Weight					
With machine electronics, approx.	240	260	300	340	kg
With machine electronics and support legs, approx.	274	294	334	374	kg
Average noise level at v_{max} measured in 1 m distance to the front side of machine	61	61	61	61	dB(A)
Drive system					
Crosshead speed $v_{min} \dots v_{max}$	0.0005 ... 600	0.0005 ... 600	0.0005 ... 600	0.0005 ... 600	mm/min
Crosshead return speed, max.	1000 ³⁾	1000 ³⁾	1000 ³⁾	1000 ³⁾	mm/min
Deviation from the set drive speed, max.	0.05	0.05	0.05	0.05	% of v_{actual}
Drive travel resolution	0.317891	0.317891	0.317891	0.317891	nm
Power input specifications					
Power supply	230	230	230	230	V, 1Ph/N/PE
Power consumption (full load), approx.	2.3	2.3	2.3	2.3	kVA

1) Support legs are included in the delivery of this testing system.

2) Including base (rectangular pipe 60 x 30 mm) with 210 mm overhang at the front

3) Values apply to machines with the safety doors closed in automatic mode and to machines without safety devices. For machines with the safety door open, the speed is reduced to 600 mm/min.

Product Information

Materials Testing Machines AllroundLine Z005 to Z100

Z100

Type	Z100 THW	Z100 TEW	
Item No.	1004500	1004501 ¹⁾	
Test load F_{max}	100	100	kN
Test area			
Height			
Lower test area	1355	1755	mm
Upper test area (additional crosshead required)	1400	1800	mm
Width	640	640	mm
Load frame			
Dimensions			
Height	1769	2169	mm
Height with support legs	1884 ... 2694	2284 ... 3094	mm
Width	960	960	mm
Width with support legs	1136	1136	mm
Width with support legs and machine electronics	1329	1329	mm
Depth with machine electronics	707 ²⁾	707 ²⁾	mm
Depth with support legs and machine electronics	781	781	mm
Weight			
With machine electronics, approx.	450	470	kg
With machine electronics and support legs, approx.	484	504	kg
Average noise level at v_{max} measured in 1 m distance to the front side of machine	66	66	dB(A)
Drive system			
Crosshead speed $v_{min} \dots v_{max}$	0.0001 ... 1500 ³⁾	0.0001 ... 1500 ³⁾	mm/min
Crosshead return speed, max.	2500 ³⁾	2500 ³⁾	mm/min
Deviation from the set drive speed, max.	0.05	0.05	% of v_{actual}
Drive travel resolution	0.484471	0.484471	nm
Power input specifications			
Power supply	400	400	V, 3Ph/N/PE
Power consumption (full load), approx.	6	6	kVA

1) Support legs are included in the delivery of this testing system.

2) Including base (rectangular pipe 60 x 30 mm) with 210 mm overhang at the front

3) Values apply to machines with the safety doors closed in automatic mode and to machines without safety devices. For machines with the safety door open, the speed is reduced to 600 mm/min.